



POLARIS TAXIWAY



Compliance to standards	<p>ICAO: International Civil Aviation Organization, Aerodromes, Annex 14, Vol. 1</p> <p>IEC TS 61827: Electrical installations for lighting and beaconing of aerodromes. Characteristics of inset and elevated luminaires used on aerodromes and heliports</p>								
Application	<p>Portable Directional Approach Runway lights indicating for airplane pilots the landing direction on an Airport runway, low and medium intensity according ICAO.</p> <p>The POLARIS design has been done in such way as to provide maximum safety.</p> <p>It is a reliable and flexible product, being easy to fit into any kind of infrastructure.</p>								
Features	<p>Designed and built with simplicity and ease of maintenance in mind. High power LED technology (100 000 hrs lifespan). IRLED - optional.</p> <p>Lightweight, low-energy and environment friendly lighting fitting.</p> <p>Autonomy: Brightness level 100% - 16hrs 30% - 53hrs 10% - 156hrs 1% - 1560hrs</p> <p>Radio controlled 868MHz (optional 915MHz) with an operating range up to 8km.</p> <p>Operating modes: Steady Flashing Visible/Infrared(optional)</p> <p>Control option: via POLARIS computer interface via remote controller local with POLARIS buttons</p>								
Product Code	<p>AL - 115 - 02 - BL</p> <table data-bbox="571 1509 1276 1635"> <tr> <td>Series Indicator (Airfield Lighting)</td> <td>AL</td> </tr> <tr> <td>Product Indicator</td> <td>115</td> </tr> <tr> <td>LEDs Number</td> <td>02</td> </tr> <tr> <td>LEDs Light Colour (blue)</td> <td>BL</td> </tr> </table>	Series Indicator (Airfield Lighting)	AL	Product Indicator	115	LEDs Number	02	LEDs Light Colour (blue)	BL
Series Indicator (Airfield Lighting)	AL								
Product Indicator	115								
LEDs Number	02								
LEDs Light Colour (blue)	BL								

Description	<p>Housing - powder coated aluminium RAL 1004 (aviation yellow) </p> <p>Dispenser - clear polycarbonate UV resistant</p> <p>Cable gland - nickel plated brass</p> <p>Fasteners - stainless steel</p> <p>Casing - polycarbonate UV resistant</p> <p>Carrying handle - aluminum</p> <p>Light fixtures are provided with anti condensation valve.</p>
Environment	<p>Temperature range: - 55° to +55°</p> <p>Degree of protection: IP X8</p> <p>Ka tested: Salt mist</p>
Mounting	<p>1. Polaris Solar panel stand AL-123-AX</p>  <p>2. Polaris base plate AL-124-AX</p> 

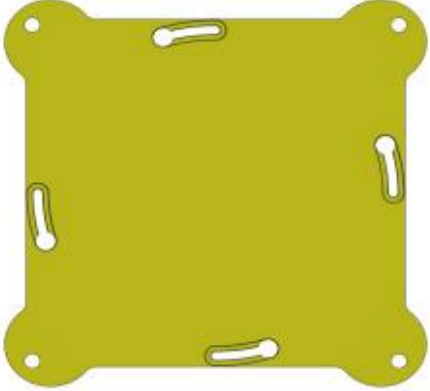
Electrical Characteristics

Power consumption: 3W for each LED

Power supply: Power supply is provided by 1 rechargeable deep cycle sealed lead acid battery 12V - 12Ah (optional different battery can be used)

Lifespan: 1200 cycles

User-replaceable

Air transportable

Battery Charging

The battery charger can be made in individual trays, in bigger racks or with solar panels.



Battery Monitoring & Charging:

The battery status is constantly monitored and a set of four LEDs gives a permanent indication.

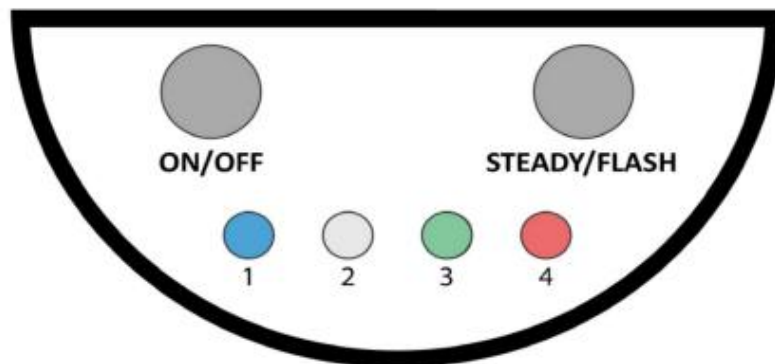

**Mechanical
Characteristics**

Width: 236.5 mm

Total height: 245 mm

Weight: 5.9 kg

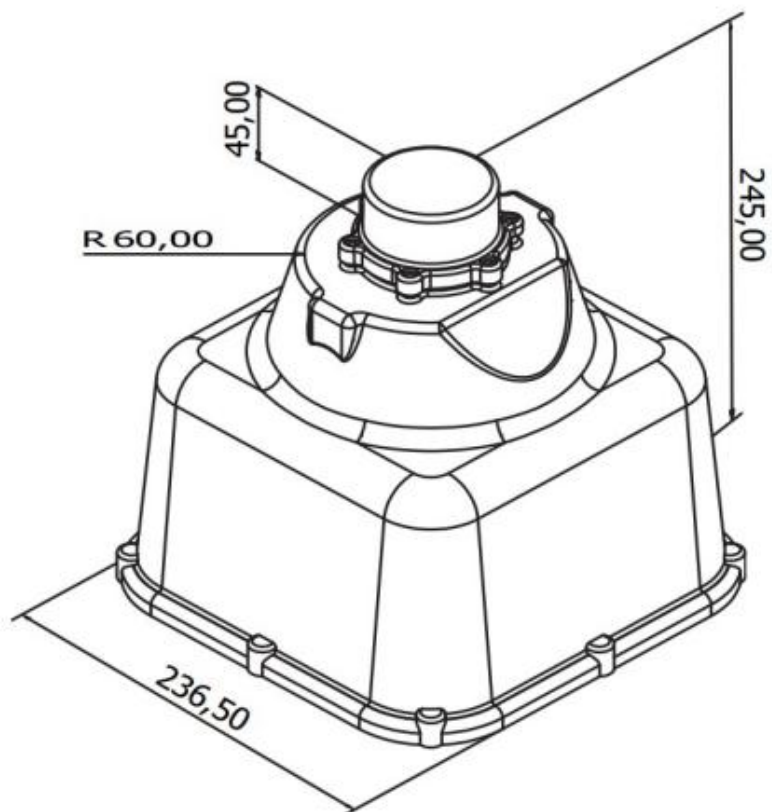

Photometric Characteristics

The intensity of taxiway edge lights shall be at least 2 cd from 00 to 60 vertical , and 0.2 cd at any vertical angles between 60 and 750 .

ICAO requirements Annex 14 Vol.1 - 5.3.18.8

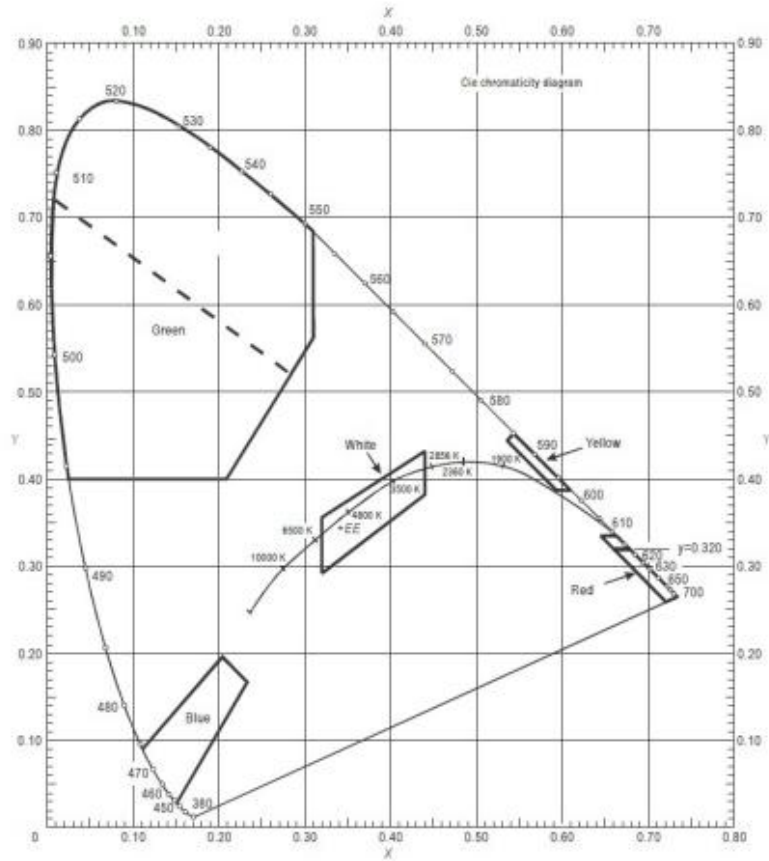



The measured trichromatic coordinates correspond to colour range requirements in:

ICAO Annex 14 - Aerodromes Vol.1, fig, A1-1-1b.

Colours for aeronautical ground lights (solid state lighting)

Accessory

1	Polaris Solar panel stand	AL-123-AX	
2	Polaris base plate	AL-124-AX	
3	Individual charger	AL-125-AX	
4	Charging rack	AL-126-AX	